

MAL209625122E3

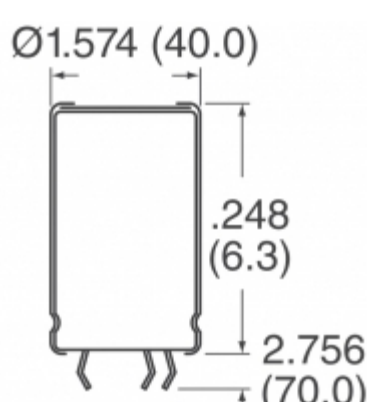

Obrázky jsou pouze orientační.
Podrobné informace o produktu naleznete v části Technické údaje produktu.
Koupit MAL209625122E3 s důvěrou od Component-World.HK, 1 rok záruka



Part Number: MAL209625122E3
Výrobce: Electro-Films (EFI) / Vishay
Popis: CAP ALUM 1200UF 20% 350V SNAP
Datový list: 096 PLL-4TSI (MAL2096) Series
 Aluminum Electrolytic Capacitors Guide

RoHS Status: Bez olova / V souladu RoHS
Ship From: Hong Kong
Shipment Way: DHL/Fedex/TNT/UPS/EMS







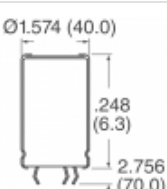
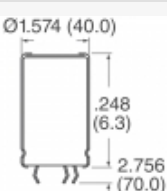

[Request For Quotation](#)

PARAMETR PRODUKTU

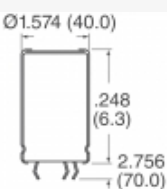
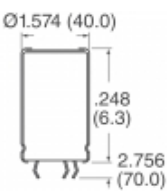
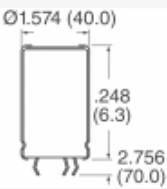
Part Number	MAL209625122E3	Výrobce	Electro-Films (EFI) / Vishay
Popis	CAP ALUM 1200UF 20% 350V SNAP	Stav volného vedení / RoHS	Bez olova / V souladu RoHS
Dostupné množství	4089 pcs	Datový list	096 PLL-4TSI (MAL2096) Series Aluminum Electrolytic Capacitors Guide
Kategorie	Kondenzátory	Napětí - Jmenovitá	350V
Tolerance	±20%	Povrchová montáž Land Velikost	-
Velikost / Rozměry	1.575" Dia (40.00mm)	Série	096 PLL-4TSI
Ripple Current @ Low Frequency	5.4A @ 100Hz	hodnocení	-
Polarizace	Polar	Obal	Tape & Box (TB)
Paket / krabice	Radial, Can - Snap-In - 4 Lead	Provozní teplota	-40°C ~ 85°C
Typ montáže	Through Hole	Úroveň citlivosti na vlhkost (MSL)	1 (Unlimited)
Výrobní standardní doba výroby	21 Weeks	Životnost @ Temp.	5000 Hrs @ 85°C
Rozestup vývodů	0.886" (22.50mm)	Stav volného vedení / RoHS	Lead free / RoHS Compliant
Impedance	59 mOhms	Výška - Sedící (Max)	2.362" (60.00mm)
ESR (Equivalent Resistance Series)	137 mOhm @ 100Hz	Detailní popis	1200µF 350V Aluminum Electrolytic Capacitors Radial, Can - Snap-In - 4 Lead 137 mOhm @ 100Hz 5000 Hrs @ 85°C
kapacitní	1200µF	Aplikace	General Purpose

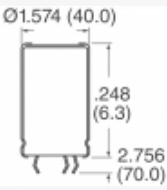
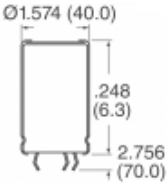
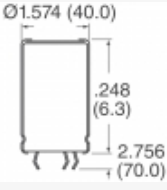
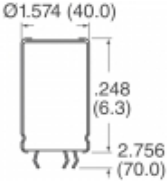
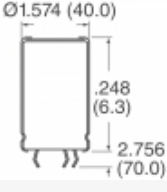
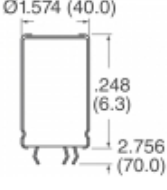
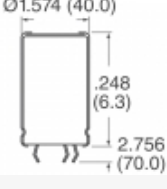
Component-World.com je spolehlivý distributor elektronických součástek. Specializujeme se na všechny elektronické komponenty řady Electro-Films (EFI) / Vishay. Máme 4089 kusy Electro-Films (EFI) / Vishay MAL209625122E3 na skladě dostupných. Vyžádejte si citát z distributora součástí elektroniky na Component-World.com, náš prodejní tým vás bude kontaktovat do 24 hodin.
RFQ Email: info@Components-World.com

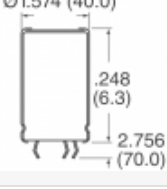
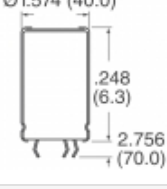
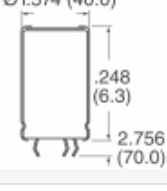
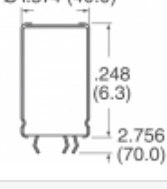
SOUVISEJÍCÍ PRODUKTY

	Část#: MAL209626182E3 Popis: CAP ALUM 1800UF 20% 400V SNAP	Výrobci: Electro-Films (EFI) / Vishay	Dotaz
	Část#: MAL209625102E3 Popis: CAP ALUM 1000UF 20% 350V SNAP	Výrobci: Electro-Films (EFI) / Vishay	Dotaz
	Část#: MAL209619561E3 Popis: CAP ALUM 560UF 20% 500V SNAP	Výrobci: Electro-Films (EFI) / Vishay	Dotaz
	Část#: MAL209624102E3 Popis: CAP ALUM 1000UF 20% 420V SNAP	Výrobci: Electro-Films (EFI) / Vishay	Dotaz
	Část#: MAL209625152E3 Popis: CAP ALUM 1500UF 20% 350V SNAP	Výrobci: Electro-Films (EFI) / Vishay	Dotaz
	Část#: MAL209625182E3 Popis: CAP ALUM 1800UF 20% 350V SNAP	Výrobci: Electro-Films (EFI) / Vishay	Dotaz
	Část#: MAL209619821E3 Popis: CAP ALUM 820UF 20% 500V SNAP	Výrobci: Electro-Films (EFI) / Vishay	Dotaz
	Část#: MAL209624152E3 Popis: CAP ALUM 1500UF 20% 420V SNAP	Výrobci: Electro-Films (EFI) / Vishay	Dotaz
	Část#: MAL209625222E3 Popis: CAP ALUM 2200UF 20% 350V SNAP	Výrobci: Electro-Films (EFI) / Vishay	Dotaz
	Část#: MAL209626821E3 Popis: CAP ALUM 820UF 20% 400V SNAP	Výrobci: Electro-Films (EFI) / Vishay	Dotaz
	Část#: MAL209626681E3 Popis: CAP ALUM 680UF 20% 400V SNAP	Výrobci: Electro-Films (EFI) / Vishay	Dotaz
	Část#: MAL209626102E3 Popis: CAP ALUM 1000UF 20% 400V SNAP	Výrobci: Electro-Films (EFI) / Vishay	Dotaz
	Část#: MAL209625821E3 Popis: CAP ALUM 820UF 20% 350V SNAP	Výrobci: Electro-Films (EFI) / Vishay	Dotaz
	Část#: MAL209624821E3 Popis: CAP ALUM 820UF 20% 420V SNAP	Výrobci: Electro-Films (EFI) / Vishay	Dotaz
	Část#: MAL209626122E3 Popis: CAP ALUM 1200UF 20% 400V SNAP	Výrobci: Electro-Films (EFI) / Vishay	Dotaz
	Část#: MAL209624122E3 Popis: CAP ALUM 1200UF 20% 420V SNAP	Výrobci: Electro-Films (EFI) / Vishay	Dotaz
	Část#: MAL209624681E3 Popis: CAP ALUM 680UF 20% 420V SNAP	Výrobci: Electro-Films (EFI) / Vishay	Dotaz
	Část#: MAL209624182E3 Popis: CAP ALUM 1800UF 20% 420V SNAP	Výrobci: Electro-Films (EFI) / Vishay	Dotaz
	Část#: MAL209626152E3 Popis: CAP ALUM 1500UF 20% 400V SNAP	Výrobci: Electro-Films (EFI) / Vishay	Dotaz
	Část#: MAL209619681E3 Popis: CAP ALUM 680UF 20% 500V SNAP	Výrobci: Electro-Films (EFI) / Vishay	Dotaz

Související klíčová slova pro MAL209625122E3

Electro-Films (EFI) / Vishay MAL209625122E3.	MAL209625122E3 distributor	MAL209625122E3 dodavatel	MAL209625122E3 Cena
MAL209625122E3 Stáhnout datasheet.	MAL209625122E3 Datasheet.	MAL209625122E3 Stock.	koupit MAL209625122E3.
Electro-Films (EFI) / Vishay MAL209625122E3.	Electro-Films (EFI) / Vishay MAL209625122E3.	Vishay Electro-Films MAL209625122E3.	Phoenix Passive Components / Vishay MAL209625122E3.